



JET PUMP + NXT CONTROLLER



PRODUCT DESCRIPTION

Self priming centrifugal pump with excellent suction capacity even in the presence of air bubbles. Suitable for pumping water with low levels of sandy impurities. Especially used in domestic water supply installations. Suitable for small farms and gardening, small scale industrial services and where self priming is necessary.

FEATURES OF PUMP

Cast-iron motor support and pump body. Motor support in die cast aluminium. Impeller, diffuser, venturi tube and sand guard in technopolymer. Stainless steel wear ring. Carbon/ceramic mechanical seal.

FEATURES OF MOTOR

Asynchronous type, closed, with external air cooling. Rotor mounted on oversized greased-for-life ball bearings, to guarantee low noise and long life. Incorporated thermo-amperometric protection and permanently inserted capacitor in the single phase version.

It is recommended to use overload protection for three phase motor protection, in compliance with current legislation. Manufactured pursuant to CEI 2-3 and CEI 61-69 (EN 60335-2-41).

CERTIFICATIONS & WARRANTY



CHARACTERISTICS

- **Operating Range:** from 10 to 90 litres/min with head up to 54 metres.
- **Liquid Quality Requirements:** clean, free from solid or abrasive contaminants, non-viscous, non-aggressive, uncrystallised and chemically neutral, close to the properties of water.
- **Liquid Temperature Range:** from 0°C to +35°C (EN 60335-2-41) for other use: from 0°C to +40°C
- **Maximum Ambient Temperature:** +40°C
- **Maximum Operating Pressure:** 8 bar (800 kPa)
- **Installation:** fixed in a horizontal position
- **Special executions on request:** different frequencies and/or voltage.
- **Motor Protection Rating:** IP 44
- **Terminal Block Protection Rating:** IP 55
- **Insulation class:** F
- **Standard Input Voltage:** Single phase 220/240 V / 50 Hz
Three phase 230/400 V - 50 Hz
- **Electrical Data:** 1.0kW 6.6A 240V

PUMP CURVE

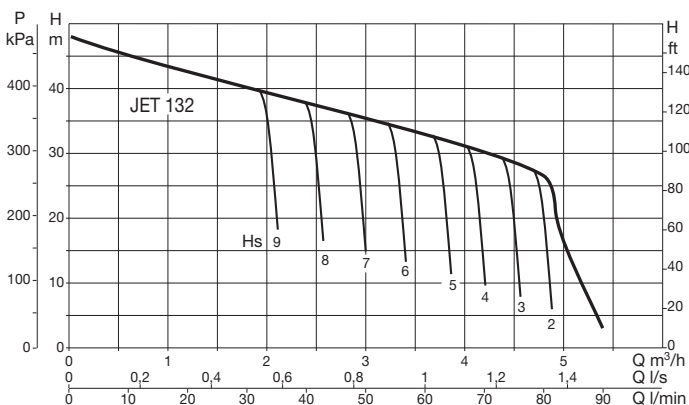

TURN OVER FOR
NXT CONTROLLER
INFORMATION



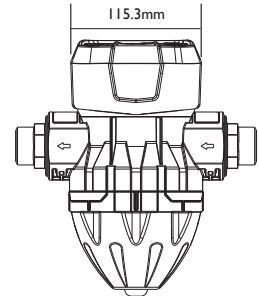
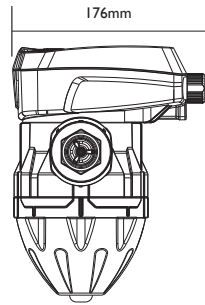
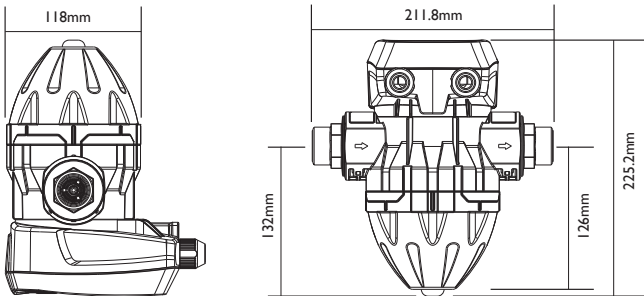
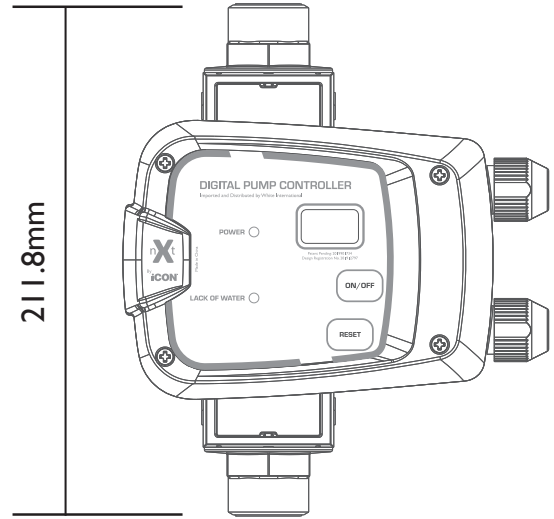

The nXt series of pump controls represents the next step in pressurised pump control.

Designed and tested in Australia to ensure operation in the toughest of environments, combining innovative technology with robust proven architecture to guarantee constant supply of pressurised water when and where you need it the most.

Ideal for pumps supplying clean, non-volatile liquids without fibers or solids in applications such as:

- Household water supply
- Irrigation
- Water transfer
- Washing systems
- Pressure boosting

Features:

- Digital display gives you a real time indication of system pressure
- Anti-cycle Protection
- Dry run protection with auto restart function that tests for water availability every 24hrs
- Anti-seize function if pump has not operated for last 24 hours
- Controller automatically restarts pump after a power failure
- Easy assembly and removal using push-n-connect fitting with U clip
- Complies to AS/NZ 4020 drinking water standard
- Over pressure protection turns pump off when 10 bar is reached
- Overload protection

CERTIFICATIONS & WARRANTY



	NXT
Function	ON/OFF
Modes	1
Size	1.5Kw
Rated Voltage	220-240V AC
Max Amps	10
Rated Power	1500w
Rating	IP65
Union Size	1"
Start Pressure	2.2 bar (32PSi)
Stop Pressure	on no flow
Max Pressure	10 bar (145PSi)
Max Liquid Temp	40°C
Cable to Pump	Plug and Play
Flylead for Pump	When sold as control only
Power Cable	10AMP
Communication	-
Accessories (Sold Separately)	-
	1 1/4" Union Kit